

FLO SOFA



This Loveseat boasts a beautiful, simple, and solid timber frame that gives it a sturdy feel while maintaining a light profile and small footprint. Its well-designed proportions ensure that it's an extremely comfortable sofa.

The fully integrated back and foam seat cushions make for a low-maintenance solution that requires minimal upkeep. Whether for a residential or commercial project, this Loveseat is the perfect addition to any space.

OPTIONS:

Custom timber & finishes are available.
Timber sub-plate below seat cushion is optional.

MATERIALS & FINISHES:

Frame in solid American oak in below finishes
Upholstery: high resilience and luxura foams.
A range of fabric and leather upholstery is available

Solid American oak with satin lacquer:



Almost Black Espresso Hazelnut Clear

DIMENSIONS:

2.0 seater / Loveseat

W:1410 x D:600 x H:740mm

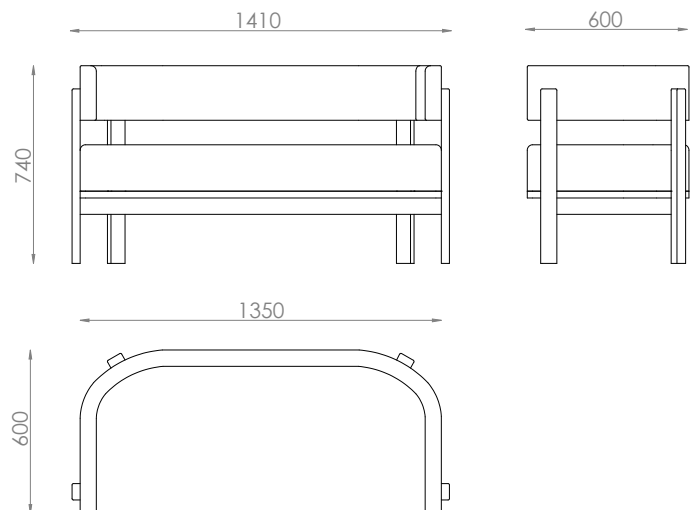

FLO SOFA

FABRIC SELECTION

HUDSON

Composition: 50% Polyester, 30% linen, 20% cotton



Flax



Ice



Jade



Mustard



Ocean



Seafoam



Steel

HUSK

Composition: 37% viscose, 24% polyester, 21% cotton, 18% linen



Agave



Cement



Cloud



Graphite

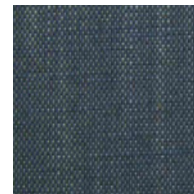

Polo



Powder

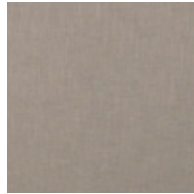

Smoke



Wattle

ALPINE

Composition: 77% Polyacrylic, 22% Polyester, 1% Viscose

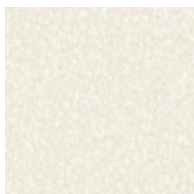

Merino



Pumice



Sable



Silver



Slate

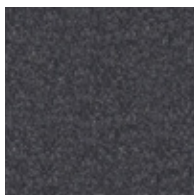

Graphite

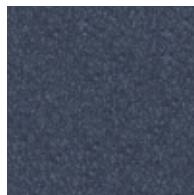

Midnight



Artichoke

** Custom fabrics or COM (customer's own materials) are available to trade only.

FLO SOFA

FABRIC SELECTION

AUGUSTUS

Composition: 70% wool, 25% polyamide, 5% Acrylic

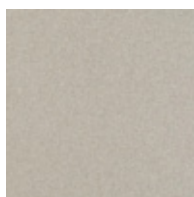

Birch

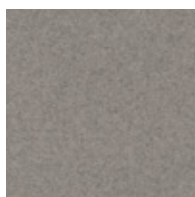

Pumice



Zinc

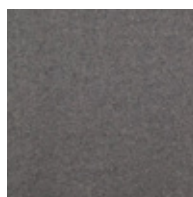

Wolf

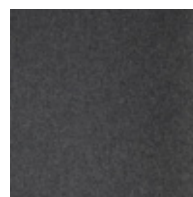

Armour

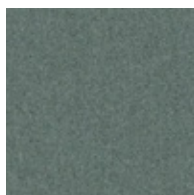

Seaglass

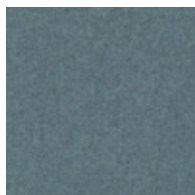

Ocean

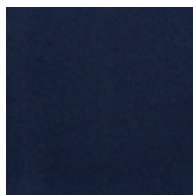

Midnight

MIX

Composition: 65% wool, 20% nylon, 15% alpaca

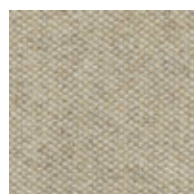

Ivory

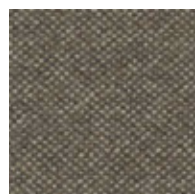

Taupe



Accorn

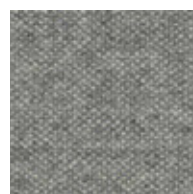

Xenon

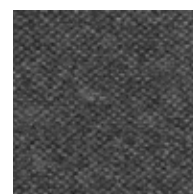

Quartz



Glacier

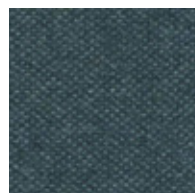

Reef

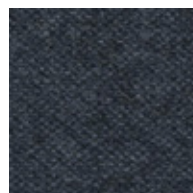

Blueberry

** Custom fabrics or COM (customer's own materials) are available to trade only.

FLO ARMCHAIR

LEATHER SELECTION

LEATHER NATUR

Type: Supple semi-aniline leather with a slight grain texture. Source: Italy

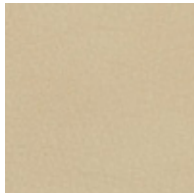

Stone



Camel

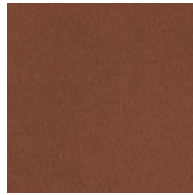

Toffee

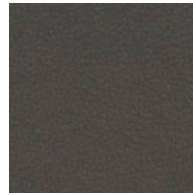

Coffee

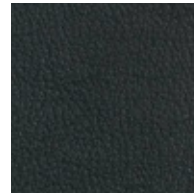

Black

LEATHER ANTICO

Type: Aniline with an aged Pull up effect. Source: Italy



Torrone

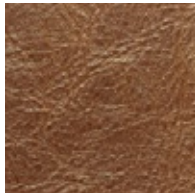

Sella

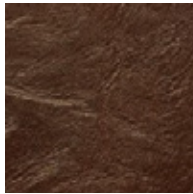

Crosta

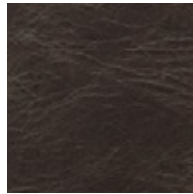

Fumo



Nero

LEATHER BRUSIO

Type: Aniline leather with a distinctive matt appearance with a beeswax finish. Source: Italy

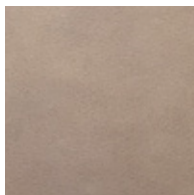

Cashew

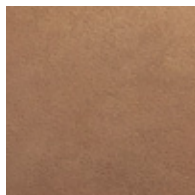

Barley

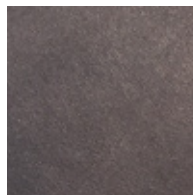

Mocca

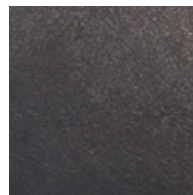

Nero

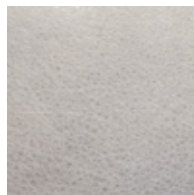

Fog

** Custom fabrics or COM (customer's own materials) are available to trade only.